

# VeriSafe™ Absence of Voltage Tester

## The Safe Way to Verify the Absence of Voltage.

When servicing electrical equipment, workers must comply with safety regulations that require a voltage verification test to validate the absence of voltage. This process includes a number of stages that can be complex and time-consuming when using hand-held portable test instruments.

The VeriSafe™ Absence of Voltage Tester from Panduit simplifies this process by automating the voltage verification process.

Once installed, a simple push of a button enables workers to verify the absence of voltage and see an active indication when the absence of voltage is confirmed. This provides a new and innovative way to safely, reliably, and efficiently verify the absence of voltage before accessing potentially dangerous electrical equipment.

By automating this process, the VeriSafe™ Absence of Voltage Tester:

- Reduces the risk of exposure of electrical hazards for improved worker safety
- Reduces testing procedure time and complexity to improve productivity
- Supports compliance when used to verify the electrical lockout/tagout process as described in NFPA 70E

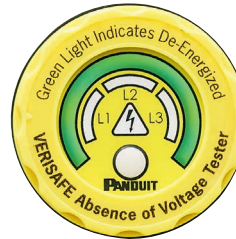

**VS-AVT**



**VS-AVT2**

The VeriSafe™ Absence of Voltage Tester minimizes risk by verifying the absence of voltage before equipment is accessed, making it easier for workers to verify an electrically safe work condition has been established in a fraction of the time compared to using hand-held portable test instruments.

### Key Features

### Benefits

<b>Improved Safety &amp; Risk Reduction</b>	Determine voltage status BEFORE equipment is accessed Prevents direct exposure to electrical hazards
<b>Increased Productivity</b>	Easy to use, initiate test with the push of a button No additional tools required Provides visual alert to abnormal power conditions
<b>Simplified Process for Easier Compliance</b>	Test sequence based on the steps in NFPA 70E for verification of an electrically safe work condition Automated test helps reduce operator errors
<b>Reliable Results</b>	Fail-safe design with active indications Safety functions meet SIL 3 per IEC 61508-1
<b>Flexible Applications</b>	Designed for testing three-phase circuits up to 600V Install on line or load side of electrical disconnect Detects absence of AC and DC voltage
<b>Multiple Environments</b>	All VeriSafe™ Absence of Voltage Testers are tested to Type (UL, NEMA and CSA) 1, 12, 13, 4, 4X, IP66, or IP67 VS-AVT2 parts are rated to Class 1 Division 2, and Class 1 Zone 2 environments

**\*The VeriSafe™ Absence of Voltage Tester satisfies the requirements for permanently mounted test devices described in NFPA 70E-2018 120.5 (7) Exception 1 when it is installed in accordance with the ratings and instructions in the VeriSafe™ AVT Installation Manual.**

# VeriSafe™ Absence of Voltage Tester

## Electrical Safety

Prior to performing de-energized work on electrical equipment, NFPA 70E requires that workers verify equipment is in an electrically safe state. Until proven otherwise, equipment must be treated as energized and necessary precautions must be observed.

One of the steps in the process of verifying that equipment is in an electrically safe state involves a test for the absence of voltage.

## Verifying the Absence of Voltage

Before and after testing, the functionality of the tester must be verified on a known source. When using a portable tester, this is a time-consuming process and may involve exposure to electrical hazards.

Using the VeriSafe™ Absence of Voltage Tester reduces risk and ensures the entire process is performed in the proper sequence – every time, every test.



## Comparison of Testing Methods

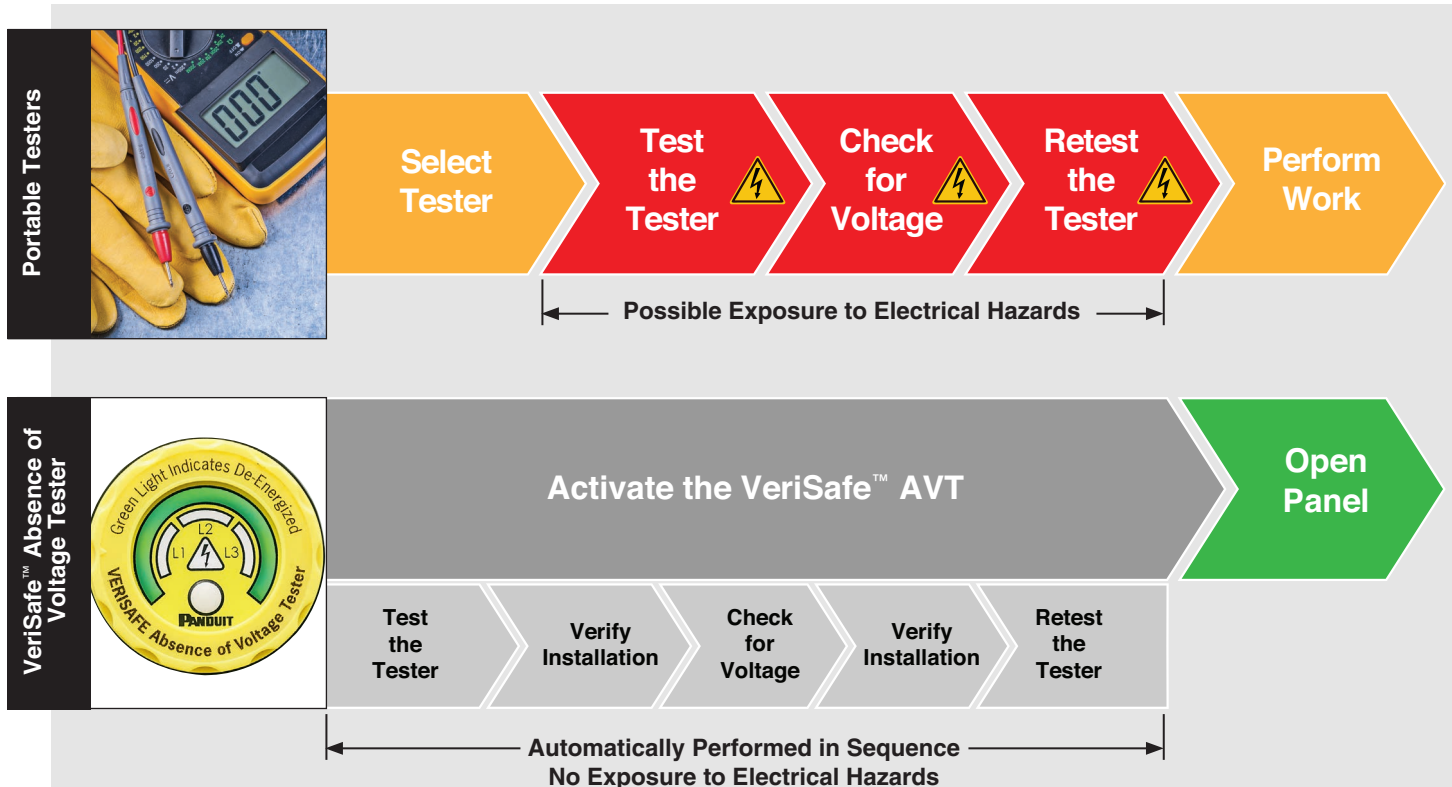

# VeriSafe™ Absence of Voltage Tester

## More than a Voltage Indicator

Voltage indicators warn of hazardous voltage, but cannot be used to confirm if equipment is de-energized. Absence of Voltage Testers are permanently-mounted test devices designed to verify that a circuit is de-energized prior to opening an electrical enclosure containing electrical conductors and circuit parts.

RED indicators illuminate when hazardous voltage is present.

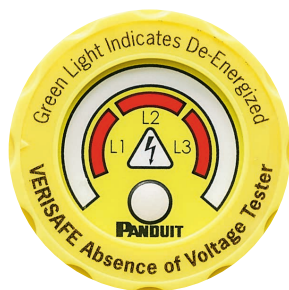

Upstream Power: ON

When AC voltage is not detected, indicators are not illuminated. This does not guarantee the absence of voltage.

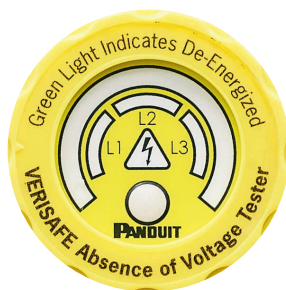

Upstream Power: OFF

Pressing the "TEST" button initiates the voltage test, indicated by the flashing YELLOW caution indicator.



Upstream Power: OFF

GREEN indicator illuminates only when the absence of voltage has been verified.

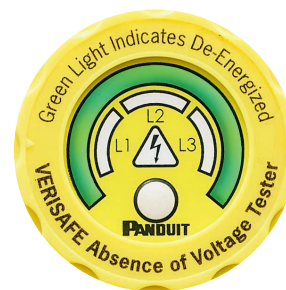

Upstream Power: OFF

Representative image only. VS-AVT used for illustration purposes.

## Absence of Voltage Testers are Fail-Safe and Reliable

- Active indicators for voltage presence and absence



- Safety functions meet SIL3 (IEC 61508)

- Comprehensive diagnostics performed as part of each absence of voltage test



Confirmation that adequate battery voltage is present



Health check of key circuit elements including the microcontroller, firmware, and processing components



Verification of connectivity between the tester and power and grounding conductors



Verification that the tester is detecting voltage in the desired range



Calibration test to verify that the test circuits are within tolerance limits



## System Components

### 1 Indicator Module

- 30mm knockout, mount on exterior of enclosure
- Operate and maintain without exposure to electrical hazards
- Instruction label with operating instructions
- VS-AVT2 will have a blue faceplate while VS-AVT will have a yellow faceplate

### 2 AVT System Cable

- Connects Isolation Module to Indicator Module
- 600V cable available in multiple lengths for easy installation
- Replaceable with connectors on each end
- Replaceable with additional lengths
- Locking connectors on both ends
- Right angle connector at indicator module saves space

### 3 Isolation Module

- Built-in overcurrent protection prevents hazardous voltage from reaching door
- Prevents hazardous voltage from reaching door
- Universal mounting (DIN rail or surface tabs)
- Output contacts provide ability to create alarms or communicate with other systems

### 4 Sensor Leads

- Can be installed on line or load side of electrical disconnect
- Two leads per phase; must be physically separated from each other
- Optimized for use with the VeriSafe™ Insulation Piercing Connector
- Use of ferrules is highly recommended

### Simple Battery Replacement

- Long-life industrial battery
- Replaceable from outside the enclosure
- Interior battery compartment is fingersafe (IP20)
- No tools required



Isolation module can be mounted to DIN rail (shown) or mounted to surface using provided mounting tabs.

**1** **PANDUIT VERISAFE** Absence of Voltage Tester  
CAT III (600V)

- Push Button to Begin Test
- ⚠ Flashing - Test in Progress
- Solid - Voltage may be Present
- Equipment De-Energized, < 3V
- Hazardous Voltage Present

Tester location:  Line  Load  Other

i

📖

➡

QR

Follow safety procedures and use required PPE

Instruction Label - VS-AVT-RL

**PANDUIT VERISAFE AVT** Diagnostic Codes

The flashes following a solid caution indicator ⚠ indicates the reason the absence of voltage was not confirmed.

# Flashes	Description
1	Battery voltage too low to run test
2	Voltage detected above threshold
4	Installation of sensor leads not verified
3, 5, 6, or 7	Hardware failure

**WARNING:** Flash codes are for diagnostic purposes ONLY. Assume presence of hazardous voltage if green light does not illuminate.

Diagnostic Label - VS-AVT-DL

# VeriSafe™ Absence of Voltage Tester

## Dimensions\*

### Indicator Module

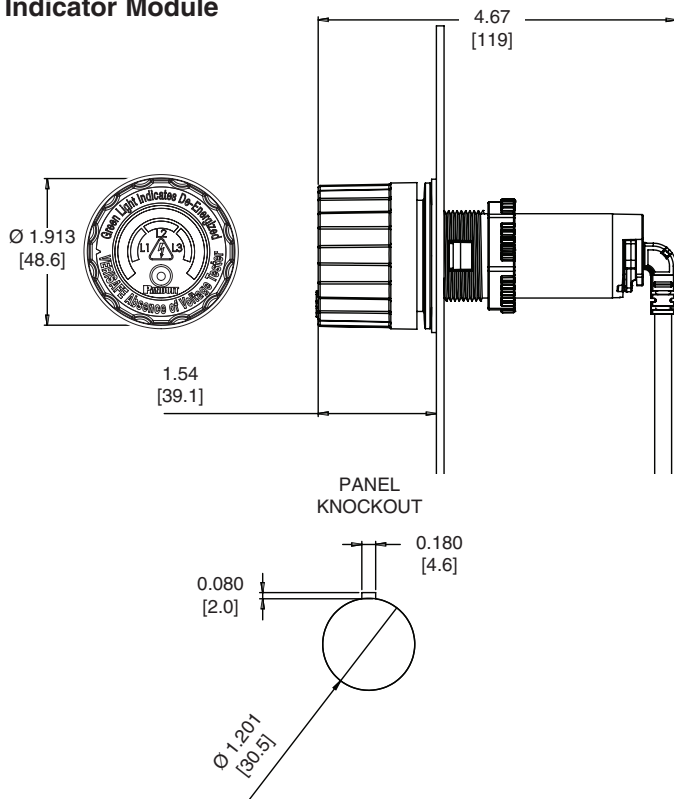

### Isolation Module

Install on DIN rail or with optional mounting tabs

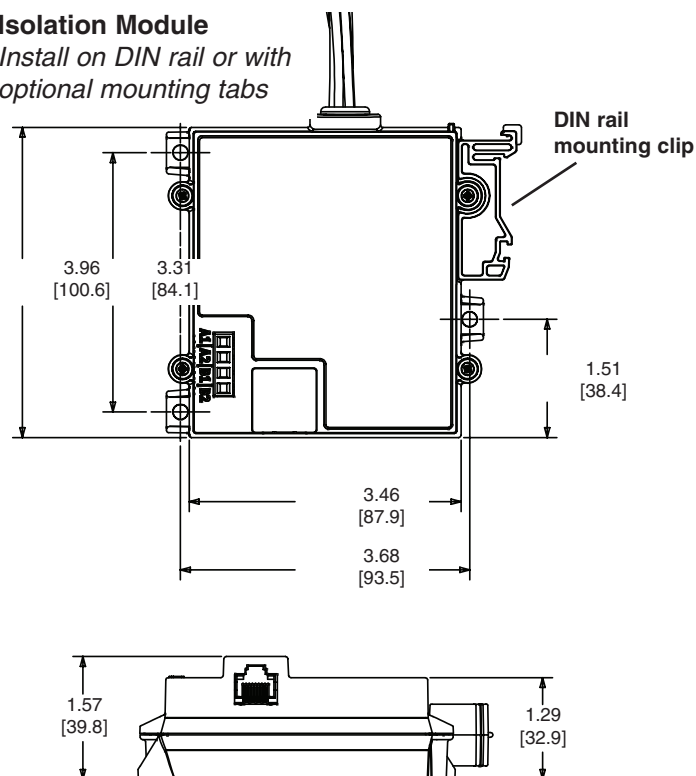

\*Dimensions in inches [millimeters].

## Connection Options



Several connection options available. For full list of installation methods, please refer to the VeriSafe™ Insulation Piercing Connector specification sheet and VeriSafe Connection Options document located on Panduit.com

**Warning:** The AVT must be installed correctly and grounded as described in the Instruction Manual to provide proper indication of absence of voltage. Sensor leads, including ground, must not be mechanically connected to each other in order for the device to verify connection to the circuit. **Use of ferrules on the AVT sensor leads are highly recommended.**

## Access Control Kit (optional)

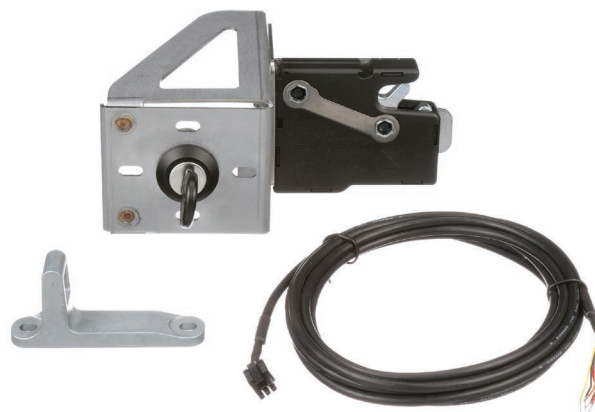

VeriSafe™ Access Control Kit is a complete hardware kit for customers looking to further their safety and security by adding an electronic latch in their disconnects and equipment

- Restrict enclosure access until the absence of voltage is confirmed
- Provides design labor and assembly savings
- Includes mechanical override
- Integrates with output contacts on AVT Isolation Module



# VeriSafe™ Absence of Voltage Tester

## Technical Specifications



### Applications

<b>Electrical System</b>	For use in 1 and 3-phase AC and DC systems
<b>Voltage Detection Range</b>	Up to 600V AC (50/60Hz), 600V DC; Rated tolerance +10%
<b>Absence of Voltage Threshold</b>	3 V
<b>Overvoltage Category</b>	III (600 V) CAT IV 300V
<b>Degree of Protection*</b>	Indicator Module: For Flat Surface Mounting in a TYPE (UL, NEMA and CSA) 1, 12, 13, 4, 4X, IP66, or IP67 Enclosure Isolation Module: Open Type, IP20

### Environment

<b>Operating Temperature (with included Tadiran TL-5903)</b>	0°C to + 60°C (32°F to 140°F)
<b>Operating Temperature (with Titus ER14505M) (VS-AVT-BATTERY)</b>	-25°C to + 60°C (-13°F to 140°F)
<b>Storage Temperature</b>	-45°C to + 85°C (-49°F to +185°F)
<b>Humidity</b>	5 to 90% non-condensing; Rated 80% at 40°C, decreasing linearly to 50% at 60°C
<b>Pollution Degree</b>	3
<b>Altitude</b>	Up to 5000 meters (3.11 miles)

### Battery

<b>Type</b>	Industrial 3.6V Lithium AA, see table in Maintenance section of installation guide for compatible batteries.
-------------	--

### Standards apply to VS-AVT and VS-AVT2

<b>UL 1436</b>	Standard for outlet circuit testers and similar indicating devices
<b>CAN/CSA-C22.2 No. 160</b>	Voltage and Polarity Testers
<b>IEC/UL/CSA C22.2 No. 61010-1</b>	Safety requirements for electrical equipment for measurement, control, and laboratory use – Part 1: General Requirements
<b>IEC/UL/CSA C22.2 No. 61010-2-030</b>	Safety requirements for electrical equipment for measurement, control, and laboratory use – Part 2-030: Particular requirements for testing and measuring circuits
<b>UL 508 &amp; CSA-C22.2 No. 14</b>	Industrial control equipment
<b>IEC 61508-1, -2, and -3 {SIL 3 Rating}</b>	Safety of Electrical/Electronic/programmable Electronic safety-related security systems – Part 1 General Requirements Part 2 Requirements for Electrical/Electronic/Programmable safety related systems Part 3 Software Requirements
<b>FCC - CFR 47 Part 15 Subpart B</b>	Radio frequency devices
<b>IEC 61326-1, -3-1, -3-1: corr 1 EN 61326-1, -3-1</b>	Electrical equipment for measurement, control and laboratory use-EMC requirements – Part 1 Part 3-1: Immunity requirements for safety-related systems and for equipment intended to perform safety-related functions (functional safety) – General industrial applications including corrigendum 1
<b>EN 55011, CISPR 11</b>	Industrial, scientific and medical equipment – Radio-frequency disturbance characteristics – Limits and methods of measurement
<b>IEC/EN61000-3-2 IEC/EN61000-3-3</b>	Electromagnetic compatibility (EMC) – Part 3-2: Limits – Limits for harmonic current emissions (equipment input current ≤ 16 A per phase)
<b>EN 61000-6-2</b>	Electromagnetic compatibility (EMC) – Part 6-2: Generic standards – Immunity for industrial environments
<b>AS/NZS CISPR 11</b>	Australian/New Zealand Standard – Industrial, scientific and medical equipment – Radio-frequency disturbance characteristics – Limits and methods of measurement
<b>CAN - ICES-001</b>	Industrial, Scientific and Medical (ISM) radio frequency generators.
<b>CE</b>	Conformity Marking for European Economic Area
<b>RoHS</b>	Restriction of hazardous substances

### Standards apply to VS-AVT2 only

<b>ISA 12.12.01</b>	Nonincendive Electrical Equipment rated for Class I, Division 2 area classification, Groups A, B, C, D, and temperature classification T3.
<b>CSA C22.2 NO. 213</b>	Nonincendive Electrical Equipment rated for Class I, Zone 2 area classification, Groups IIA, IIB, and IIC, and temperature classification T3.

\*Degree of protection specified is related to the Indicator Module only. To meet the TYPE (UL, NEMA and CSA) 1, 12, 13, 4 or 4X requirements, mount on a flat surface of an enclosure meeting the appropriate UL TYPE or NEMA rating. Verify that the seal and o-rings are clean to ensure proper sealing.

# VeriSafe™ Absence of Voltage Tester System

## Ordering Information

Part Number	Part Description
-------------	------------------

### VeriSafe™ Absence of Voltage Testers

VS-AVT-C02-L03	VeriSafe™ Absence of Voltage Tester with 2 ft. system cable, 3 ft. sensor leads.
VS-AVT-C08-L10	VeriSafe™ Absence of Voltage Tester with 8 ft. system cable, 10 ft. sensor leads.
VS-AVT2-C02L03	VeriSafe™ Absence of Voltage Tester for Class 1 Division 2 hazardous locations - 2 ft. system cable, 3 ft. sensor leads.
VS-AVT2-C08L10	VeriSafe™ Absence of Voltage Tester for Class 1 Division 2 hazardous locations - 8ft. system cable, 10ft. sensor leads.

### Sensor Lead Connection Kits

VS-CKP14-6	VeriSafe™ Insulation Piercing Connection Kit for Tapping 14 to 6 AWG conductors. Kit includes 3 connectors for installment of 1 AVT.
VS-CKP4-000	VeriSafe™ Insulation Connection Kit for Tapping 4 to 3/0 AWG conductors. Kit includes 3 connectors for installment of 1 AVT.

### Equipment Retrofit Kits

VS-AVT-RKP1	Complete kit to retrofit equipment with VeriSafe™ Absence of Voltage Tester. Includes AVT device with 10ft. sensor leads, 8ft. system cable, VeriSafe™ Insulation Piercing Connection Kit 14-6 AWG power connectors, (12) cable ties, (6) cable ties mounts, (1) wire marker card.
VS-AVT-RKP2	Complete kit to retrofit equipment with VeriSafe™ Absence of Voltage Tester. Includes AVT device with 10ft. sensor leads, 8ft. system cable, VeriSafe™ Insulation Piercing Connection Kit 4 - 3/0 AWG power connectors, (12) cable ties, (6) cable ties mounts, (1) wire marker card.

### VeriSafe™ Retrofit Enclosure

VS-AVT-RBOX	Complete enclosure to retrofit equipment with VeriSafe™ Absence of Voltage Tester (AVT). Includes 8" x 8" x 4" panel and VeriSafe™ AVT device with 10ft. sensor leads and 2ft. system cable.
-------------	--

### Accessories

VS-AVT-CABLE-02	AVT System Cable for use with VeriSafe™ AVT device. Cable length is 2ft.
VS-AVT-CABLE-04	AVT System Cable for use with VeriSafe™ AVT device. Cable length is 4ft.
VS-AVT-CABLE-08	AVT System Cable for use with VeriSafe™ AVT device. Cable length is 8ft.
VS-AVT-CABLE-16	AVT System Cable for use with VeriSafe™ AVT device. Cable length is 16ft.
VS-AVT-CABLE-20	AVT System Cable for use with VeriSafe™ AVT device. Cable length is 20ft.
VS-AVT-CABLE-30	AVT System Cable for use with VeriSafe™ AVT device. Cable length is 30ft.
VS-AVT-RL	VeriSafe™ AVT Replacement Label. Includes replacement labels in all languages for the Instruction Label and Cap Label.
VS-AVT-DL	VeriSafe™ AVT Diagnostic Label.
VS-AVT-BATTERY	VeriSafe™ AVT Replacement Battery.

### VeriSafe™ Access Control

VS-ACK-CPWR	Access control kit for use iwth VeriSafe AVTs. Includes electronic latch, mounting hardware, and mechanical override. Requires 12-24Vdc power (not included).
VS-ACK-EXT	Access Control Extension Kit for use with VS-ACK-CPWR. Extends latch assembly 5.5" from side mounting surface.
VS-ACK-KEY	Master override key for use with VeriSafe Access Contorl Kit VS-ACK-CPWR.
VS-ACK-BATTERY	Battery pack for use with VeriSafe Access Contorl Kit VS-ACK-CPWR.

### International Options

VS-AVT-C02-L03E	VeriSafe™ Absence of Voltage Tester with 0.9m sensor leads and 0.6m system cable. For use in EMEA.
VS-AVT-C08-L10E	VeriSafe™ Absence of Voltage Tester with 3.0m sensor leads and 2.4m system cable. For use in EMEA.
VS-AVT-C02-L03A	VeriSafe™ Absence of Voltage Tester with 0.9m sensor leads and 0.6m system cable. For use in APAC.
VS-AVT-C08-L10A	VeriSafe™ Absence of Voltage Tester with 3.0m sensor leads and 2.4m system cable. For use in APAC.

## WORLDWIDE SUBSIDIARIES AND SALES OFFICES

PANDUIT CANADA  
Markham, Ontario  
cs-cdn@panduit.com  
Phone: 800.777.3300

PANDUIT EUROPE LTD.  
London, UK  
cs-emea@panduit.com  
Phone: 44.20.8601.7200

PANDUIT SINGAPORE PTE. LTD.  
Republic of Singapore  
cs-ap@panduit.com  
Phone: 65.6305.7575

PANDUIT JAPAN  
Tokyo, Japan  
cs-japan@panduit.com  
Phone: 81.3.6863.6000

PANDUIT LATIN AMERICA  
Guadalajara, Mexico  
cs-la@panduit.com  
Phone: 52.33.3777.6000

PANDUIT AUSTRALIA PTY. LTD.  
Victoria, Australia  
cs-aus@panduit.com  
Phone: 61.3.9794.9020

For a copy of Panduit product warranties, log on to [www.panduit.com/warranty](http://www.panduit.com/warranty)



For more information  
Visit us at [www.panduit.com](http://www.panduit.com)  
Contact Customer Service by email: [cs@panduit.com](mailto:cs@panduit.com)  
or by phone: 800.777.3300

©2019 Panduit Corp.  
ALL RIGHTS RESERVED.  
Printed in the U.S.A.  
SFCB16--SA-ENG  
Replaces SFCB16--SA-ENG  
10/2019